



DADO





GELATEC

#DADO

G
GELATEC



DADO DISPLAY LINE IS MANUFACTURED TO THE FOLLOWING VERSIONS:

1. VENTILATED ICE CREAM

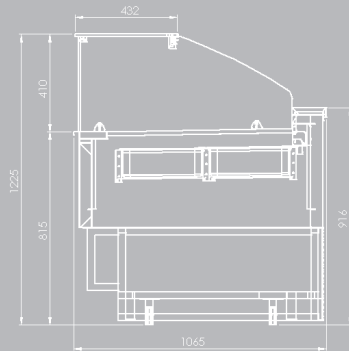

PERFORMANCE

FUNCTIONING TEMPERATURE	- 20
PRODUCT CONSERVATION TEMPERATURE	- 18
CLIMATIC CLASS	+ 4
COMPRESSOR TYPE	HERMETIC
DEFROST	REVERSE CYCLE
REFRIGERANT GAS	R404A
ELECTRIC POWER SUPPLY V/PH/Hz	400/3/50

THIS LINE HAS BEEN PROJECTED WITH PARTICULAR ATTENTION TO THE EASY CLEANING OPERATIONS AND FOR THE PERFECT CONSERVATION OF THE PRODUCTS EVEN IN CLIMATIC CONDITIONS 4+ CLASS.

#DADO

G
GELATEC



1. VENTILATED ICE CREAM

L 1150 / 12 TRAYS	
H	1200
W	980
KG	130

L 1660 / 18 TRAYS	
H	1200
W	1400
KG	180

L 2160 / 24 TRAYS	
H	1200
W	2000
KG	240

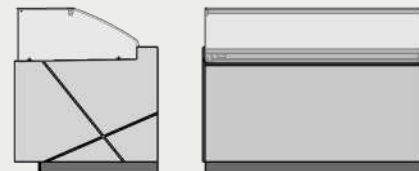

- THE SHOWCASE'S BODY IS MADE BY STAINLESS STEEL AISI 304 INSULATED WITH ECOLOGICAL POLYURETHANE WITH DENSITY 42KG/M3.
- THE SYSTEM IS CONTROLLED BY ELECTRONIC THERMOSTAT WITH INSULATION INDEX IP65 AND LED DISPLAY.
- THE EVAPORATOR HAS BEEN TREATED WITH A SPECIAL ANTITOXIC PIGMENT IN ORDER TO AVOID THE TRANSMISSION OF TOXICITY TO THE PRODUCTS.
- THE LIGHTING SYSTEM IS TB LED LAMPS TO PREVENT OVERHEATING IN THE REFRIGERATED SPACE.
- THE DOUBLE CRYSTALS ARE HEATED ON ALL SIDES TO AVOID HUMIDITY CONDENSING ISSUES.
- DADO LINE CAN GUARANTEE THE IDEAL ICE CREAM CONSERVATION AND HOMOGENEOUS TEMPERATURE IN ALL THE LENGTH OF THE DISPLAY EVEN USING THE "MOUNTAIN GELATO" TECHNIQUE.
- POLYCARBONATE SLIDING DOORS IN THE BACK FOR EASY AND QUICK ACCESS BY THE USER.

AFFORDABLE TECHNOLOGY ...



... MEET HIGH AESTHETICS.



L 1150

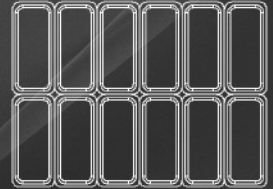

L 1660

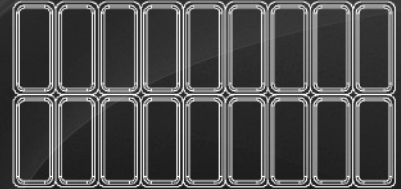

L 2160

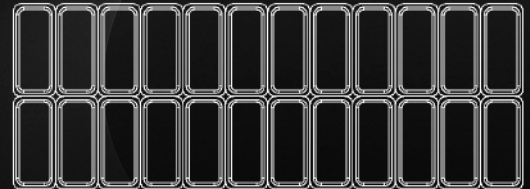

TRAYS

THIS LINE HAS BEEN DESIGNED FOR
ICE CREAM TRAYS 360X165X120 MM.

COATING

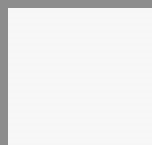

GC 001



GC 003

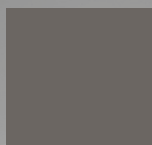

GC 011

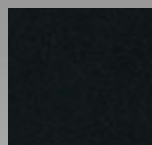

GC 016



GC 017



GC 019



GC 025



GC 028

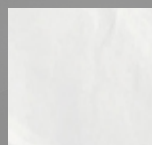

GC 039



GC 050

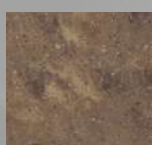

GC 056

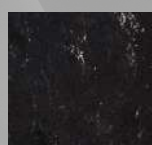

GC 054

ACRYLIC STONE

STONE VENEER



GV 083



GV 067

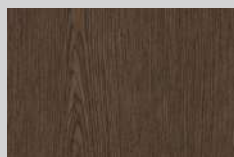

GV 018



GV 039

VENEER



#DADO



GELATEC

CUSTOM DESIGN LAB

THESSALONIKI INDUSTRIAL AREA ROAD 488

P.BOX 1005 P.C. 57022 SINDOS- GREECE

TEL 0030 2310 797707

EMAIL: INFO@GELATEC.IT

WWW.GELATEC.IT